

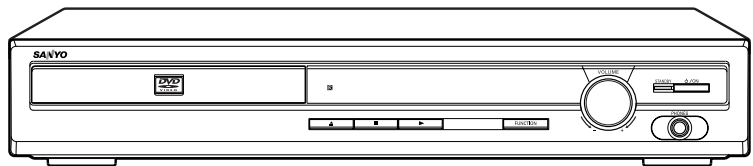

# INSTRUCTION MANUAL

# DC-TS750

## DVD Home Theatre System

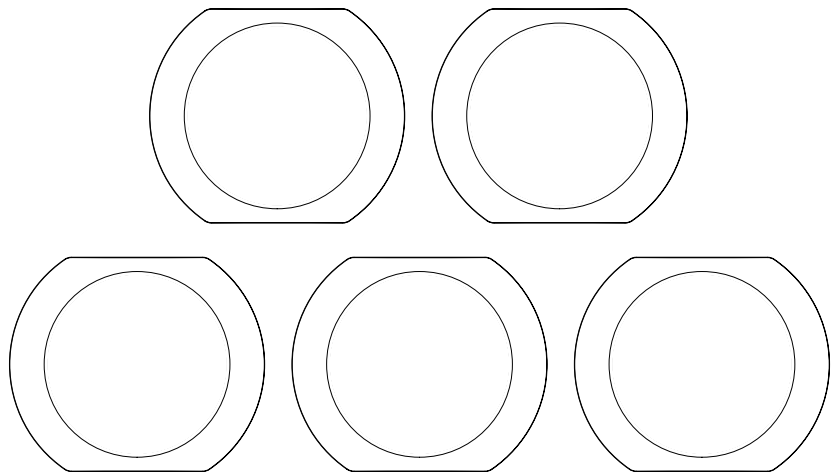
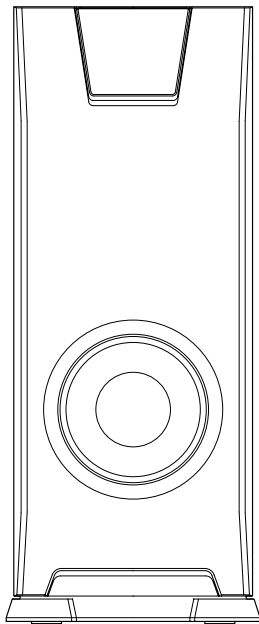

# TABLE OF CONTENTS

PRECAUTIONS .....	1	VARIOUS DISC PLAYING FUNCTIONS .....	14
CONTROLS .....	2	MP3 CD OPERATION .....	17
REMOTE CONTROL .....	3	INITIAL SETTINGS .....	18
BASIC CONNECTIONS .....	4	LANGUAGE CODE LIST .....	20
ADDITIONAL CONNECTIONS EXAMPLES .....	7	LISTENING TO OTHER SOURCES .....	21
SYSTEM CONNECTIONS EXAMPLES .....	8	LISTENING TO THE RADIO .....	21
BEFORE OPERATION .....	10	TIMER OPERATION .....	22
ADJUSTING THE CLOCK .....	10	MAINTENANCE .....	23
VARIOUS ADJUSTING .....	11	TROUBLESHOOTING GUIDE .....	23
PLAYABLE DISCS .....	12	SPECIFICATIONS .....	24
DISC PLAY .....	13		

## PRECAUTIONS

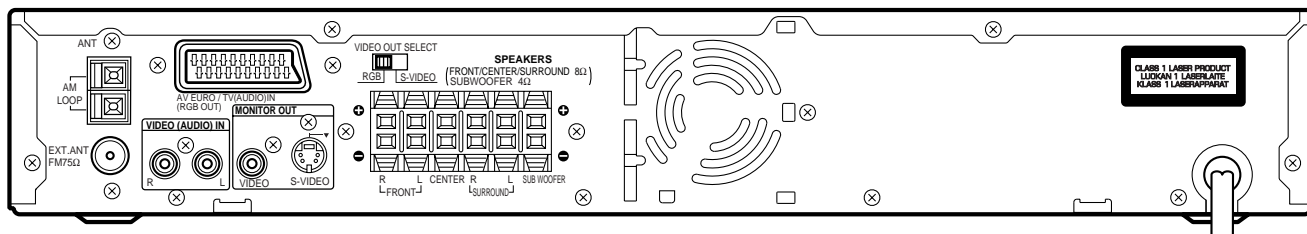

### CAUTION

THIS PRODUCT CONTAINS A LOW POWER LASER DEVICE, TO ENSURE CONTINUED SAFETY DO NOT REMOVE ANY COVERS OR ATTEMPT TO GAIN ACCESS TO THE INSIDE OF THE PRODUCT. REFER ALL SERVICING TO QUALIFIED PERSONNEL.

- The apparatus shall not be exposed to dripping or splashing.
- No objects filled with liquids, such as vases, shall be placed on the apparatus.
- Do not use where there are extremes of temperature (below 5°C or exceeding 35°C) or where direct sunlight may strike it.
- Because of the DVD player's extremely low noise and wide dynamic range, there might be a tendency to set the volume on the amplifier unnecessarily high. Doing so may produce an excessively large output from the amplifier which could damage your speakers.
- Sudden changes in the ambient temperature may cause condensation to form on the optical lens inside the unit. If this happens, take out the disc, leave the unit for about 1 hour, and then proceed to operate.
- When carrying the unit, be sure to remove any disc which may be inside and turn the power off. Wait at least 10 seconds, then unplug the mains lead from the AC outlet. Carrying the unit with a disc inside may damage the disc and/or the unit.
- Do not install this equipment in a confined space, such as a book case or built in cabinet.
- Placing the unit in a well ventilated area is strongly recommended. Do not place any object on the top of the unit. Do not block ventilation holes. The cabinet of the unit warms up when it is used for a long time, but it is not a malfunction.

### Important Information:

To connect this unit to a TV, TV must have a Video input socket or an EURO-AV/SCART socket. You cannot use an RF input socket or aerial terminal to connect this unit.

This product incorporates copyright protection technology that is protected by method claims of certain U.S. patents and other intellectual property rights owned by Macrovision Corporation and other rights owners. Use of this copyright protection technology must be authorized by Macrovision Corporation, and is intended for home and other limited viewing uses only unless otherwise authorized by Macrovision Corporation. Reverse engineering or disassembly is prohibited.

### IMPORTANT

If the plug supplied with this equipment is not suitable for the socket outlets in your home it should be cut off and replaced with the correct type.

#### Disposal of Plug

If the non rewirable plug is to be cut off, the removed plug should be disposed of carefully as there is a shock hazard should the plug be inserted into a live socket.

#### Replacing Fuse

The detachable fuse cover must be replaced after changing the fuse. Only a 3A fuse should be used and should comply with BS1362 and should carry the ASTA mark .

The wires in the mains lead are coloured in accordance with the following code;

Blue	Neutral
Brown	Live

The wires in the mains lead must be connected to the terminals in the plug as follows;

Wire colour	Plug terminal marking
Blue	N or Black or Blue
Brown	L or Red or Brown

Do not connect either wire to the earth terminal. If the mains plug contains a fuse this should be 3A, if a plug without a fuse is used the distribution board fuse should not be greater than 5A.

The unit is not disconnected from the mains unless it is unplugged from the AC outlet.

# CONTROLS

## Front panel

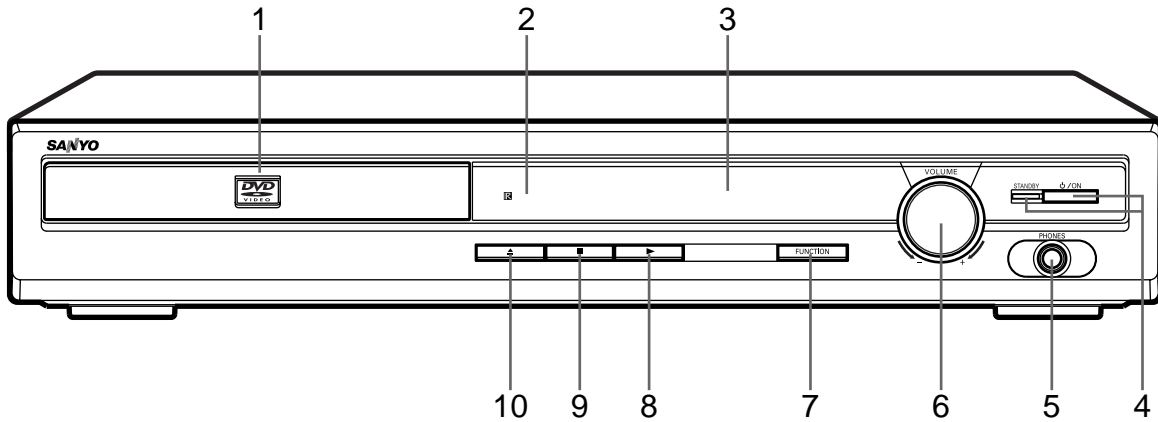

- |   |                               |
|---|-------------------------------|
| 1. Disc tray                                      | 6. Volume control (VOLUME)    |
| 2. Remote sensor (IR)                             | 7. Function button (FUNCTION) |
| 3. Display  | 8. Play button (▶)            |
| 4. Power button/Standby indicator (⏻/ON, STANDBY) | 9. Stop button (■)            |
| 5. Headphones socket (PHONES)                     | 10. Open/Close button (⏏)     |

## Display

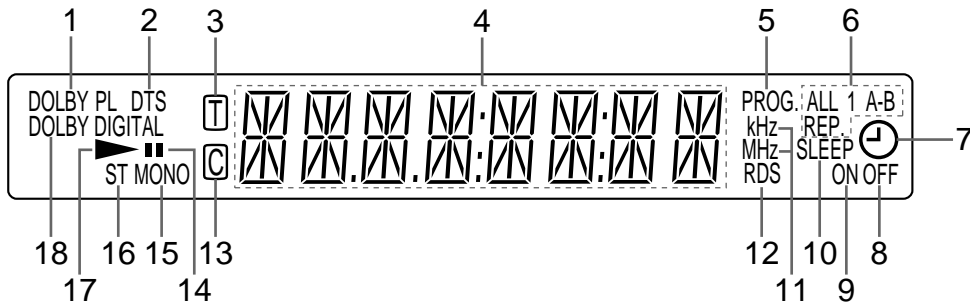

- |   |   |
|---|---|
| 1. Dolby Pro Logic indicator (DOLBY PL)   | 11. Kilohertz indicator (kHz)/Megahertz indicator (MHz) |
| 2. DTS indicator (DTS)  | 12. RDS indicator (RDS)                                 |
| 3. Title and Track indicator (T)  | 13. Chapter indicator (C)                               |
| 4. Message or number indicators<br>(Title, chapter, track, playing time or other information) | 14. Pause indicator (⏏)                                 |
| 5. Programme indicator (PROG.)  | 15. FM mono indicator (MONO)                            |
| 6. Repeat mode indicators (ALL, 1, A-B, REP.)   | 16. FM stereo indicator (ST)                            |
| 7. Timer indicator (⌚)  | 17. Play indicator (▶)                                  |
| 8. Timer off indicator (OFF)  | 18. Dolby Digital indicator (DOLBY DIGITAL)             |
| 9. Timer on indicator (ON)  |   |
| 10. Sleep indicator (SLEEP)   |   |

## ACCESSORIES

- |  |  |
|--|--|
| RB-TS750ST remote control                | Front left speaker lead (Black and Blue)       |
| R6 (HP 7) battery x 2                    | Centre speaker lead (Black and Green)          |
| AM loop aerial                           | Surround right speaker lead (Black and Orange) |
| FM aerial wire                           | Surround left speaker lead (Black and Gray)    |
| Video lead                               | Subwoofer lead (Black and Brown)               |
| Front right speaker lead (Black and Red) | Screw kit                                      |

# REMOTE CONTROL

**Note:**

In this instruction manual, any operation of pressing any button while pressing the SHIFT button is as shown below.

Example: "Press the **SHIFT + 1 ANGLE** buttons."

**Controls**

1. Power button (ON/OFF)
2. Number and other function buttons

Number buttons (1 - 9, 0)  
 Angle button (ANGLE)  
 Angle replay button (A.REPLAY)  
 Zoom button (ZOOM)  
 Audio button (AUDIO)  
 Sleep button (SLEEP)  
 Timer button (TIMER)  
 Adjust button (ADJUST)  
 Set/Clear button (SET/CLEAR)  
 Clock button (CLOCK)

3. TV control buttons

**Note:**

- Only SANYO TVs can be operated using this remote control.
- There may be some older TV models that cannot be operated with this remote control. If this is the case, use the original remote control supplied with the TV.

Power button (TV POWER)  
 TV/Video select button (TV/VIDEO)  
 Channel scanning buttons (TV CH)

4. Tuner controls

Radio data system mode button (RDS)  
 Tuner function/Band select button (TUNE/BAND)  
 Tuning/Programme type select buttons (TUNE/PTY)  
 Preset tuning/Programme type check buttons (PRESET/PTY CHK)

5. Amplifier controls

Surround button (SURROUND)  
 Muting button (MUTE)  
 Bass button (BASS)  
 Sound preset button (SOUND)  
 Function button (FUNCTION)  
 Volume buttons (VOLUME)

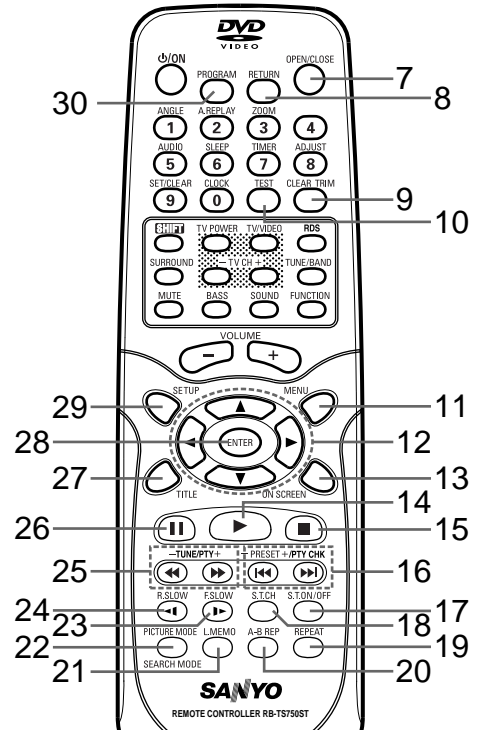
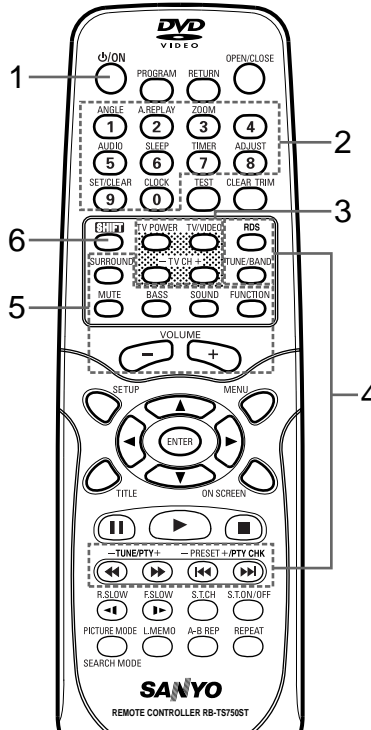

6. Shift button (SHIFT)
7. Open/Close button (OPEN/CLOSE)
8. Return button (RETURN)
9. Clear/Trim button (CLEAR/TRIM)
10. Test tone button (TEST)
11. Menu button (MENU)
12. Directional arrow buttons (▲, ►, ▼, ◀)
13. On-screen display button (ON SCREEN)
14. Play button (▶)
15. Stop button (■)
16. Skip/Next/Previous buttons (◀◀, ►►)
17. Subtitle on/off button (S.T.ON/OFF)
18. Subtitle change button (S.T.CH)
19. Repeat button (REPEAT)
20. A-B repeat button (A-B REP)

21. Last memory button (L.MEMO)
22. Picture mode/Search mode button (PICTURE MODE/SEARCH MODE)
23. Forward slow button (F.SLOW ►)
24. Reverse slow button (R.SLOW ◀)
25. Fastforward/Fast reverse buttons (◀◀, ►►)
26. Pause/Step button (⏸)
27. Title button (TITLE)
28. Enter button (ENTER)
29. Setup button (SETUP)
30. Programme button (PROGRAM)

**Inserting batteries**

Install two "R6 (HP 7)" batteries.

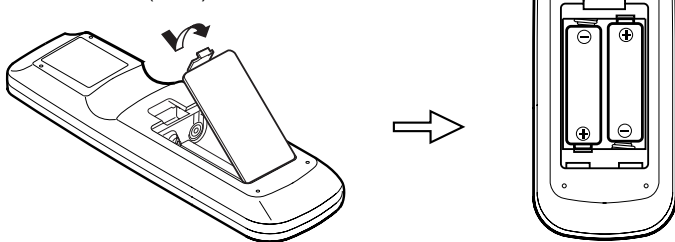

**Note:**  
 Remove the batteries if the remote control is not to be used for a month or more. Batteries left in the unit may leak and cause damage.

**Remote control range**

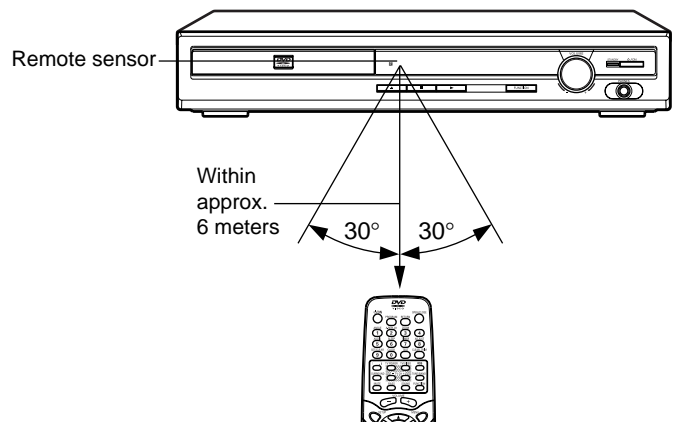

# BASIC CONNECTIONS

After all connections have been made, connect the mains lead to an AC outlet .

Note:

- Do not connect the mains lead to an AC outlet until all connections have been made.
- The system is not completely disconnected from the mains when the ⏻/ON button is set to the ⏻ position.

## Speaker connections

To achieve proper stereo reproduction, connect the speaker wires without shorting to adjacent wires as shown in figure.

Speaker wire colour	Use
Black and Red	Front right speaker
Black and Blue	Front left speaker
Black and Green	Centre speaker
Black and Orange	Surround right speaker
Black and Gray	Surround left speaker
Black and Brown	Subwoofer

Note:

The SPEAKERS sockets are designed for use only with the supplied speakers. Do not use with other speakers. Connecting other speaker may damage the speaker and/or the unit.

If using other speakers, check their impedance/input power.

FRONT/CENTER/SURROUND: 8 Ω or more/40 W or more  
SUBWOOFER: 4 Ω or more/80 W or more

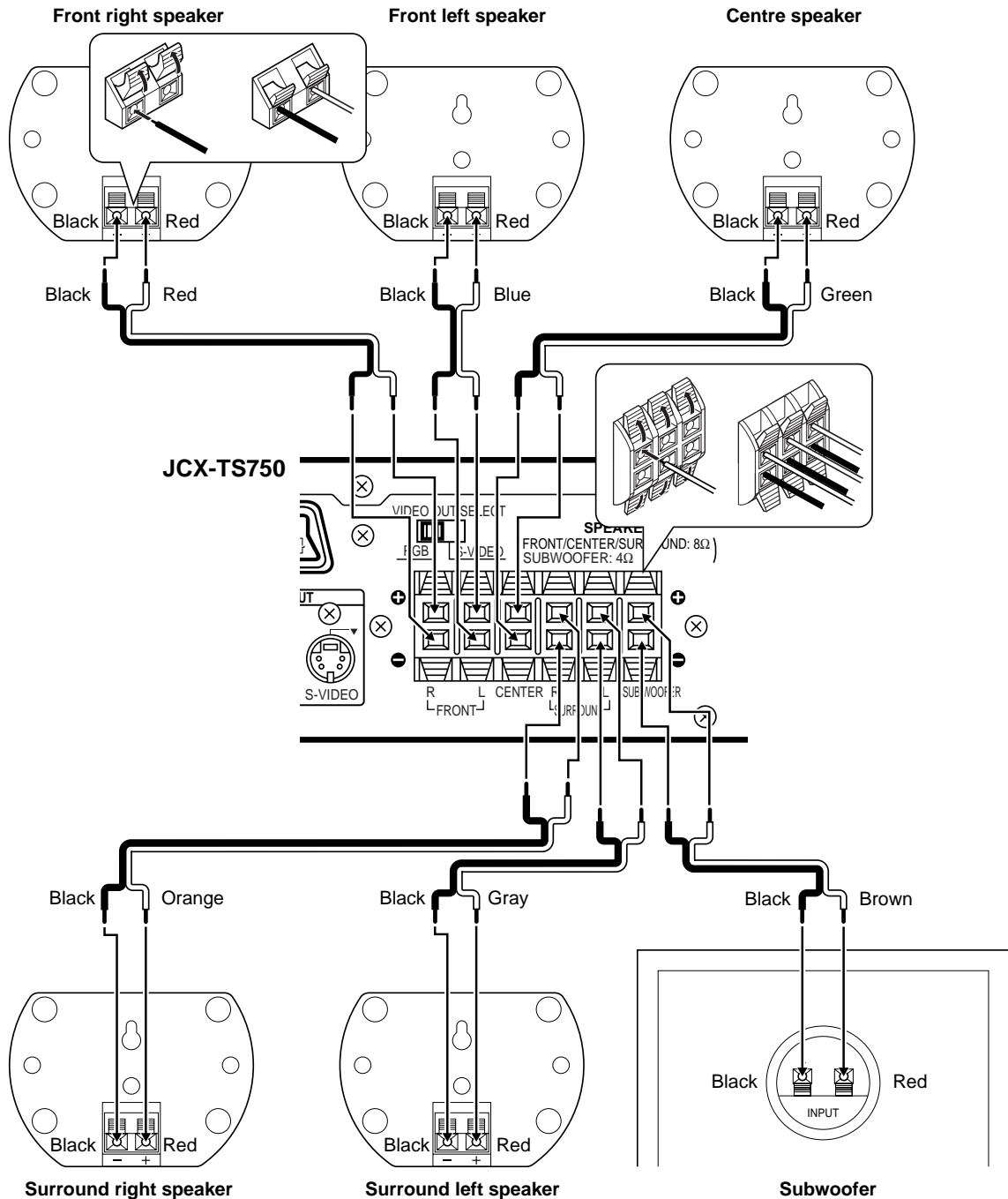

## Speaker placement

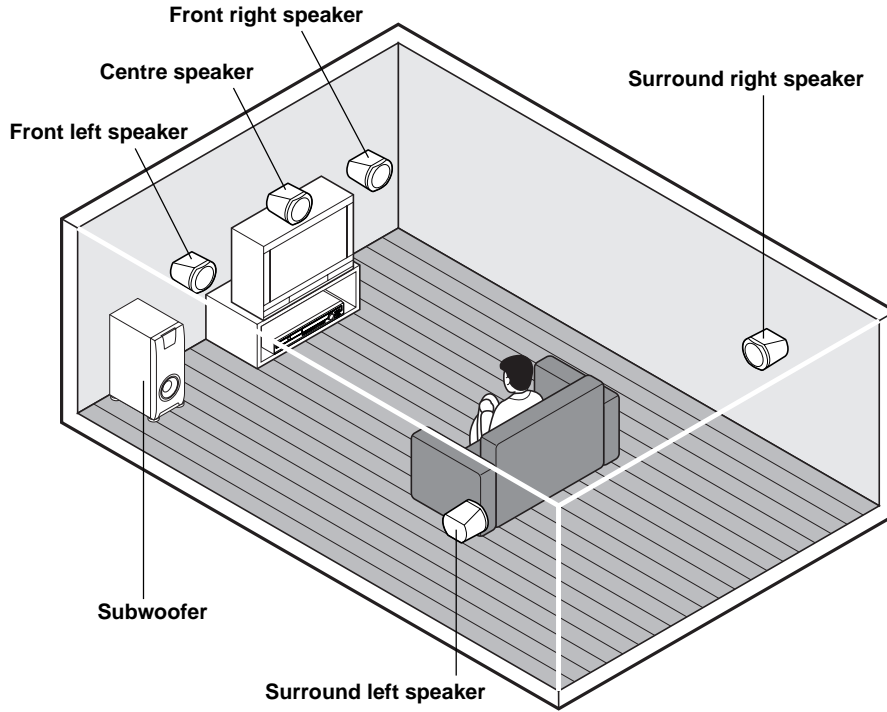

The supplied speakers have built-in magnetic stray field compensation. They may be placed close to a TV without affecting the colour purity. The five speakers are all the same and can be used for front left, centre, front right, surround left and surround right speakers.

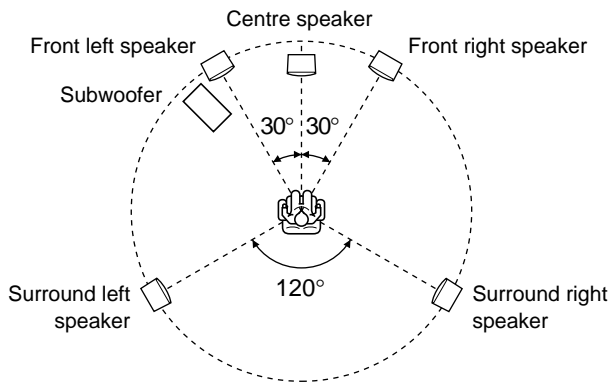

The front, centre, and surround speakers should be placed at approximately the same distance from the listening position. Place the front left and right speakers either side of the TV. Place the centre speaker directly above the TV. Place the surround speakers either sides of the listening position, or slightly to the rear, approximately 60 cm ~ 1 meter higher than ear level. The subwoofer can be placed near the front speaker and not too far from the TV.

**Note:**

- The angles in the diagramme are approximate.
- Please refer to "Setting audio" on page 19.

### Example: To hang the speaker on a wall

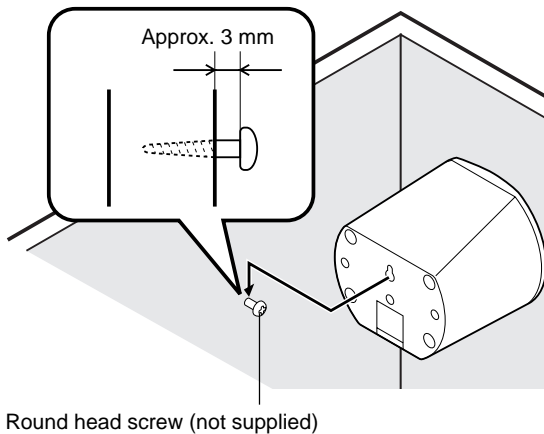

### Example: To mount the speaker with a stand

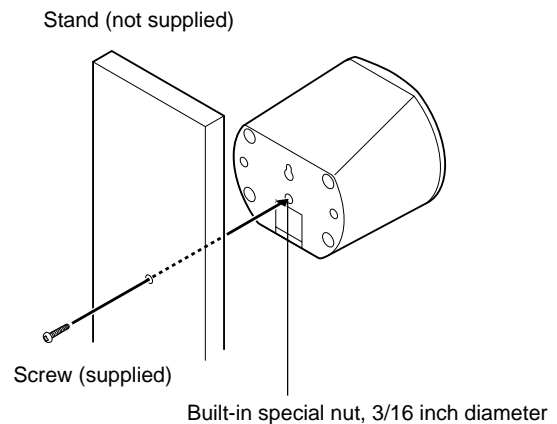

Note: Take care when installing the speakers. They may cause damage or serious injury should they fall from their mountings.

## Aerial connections

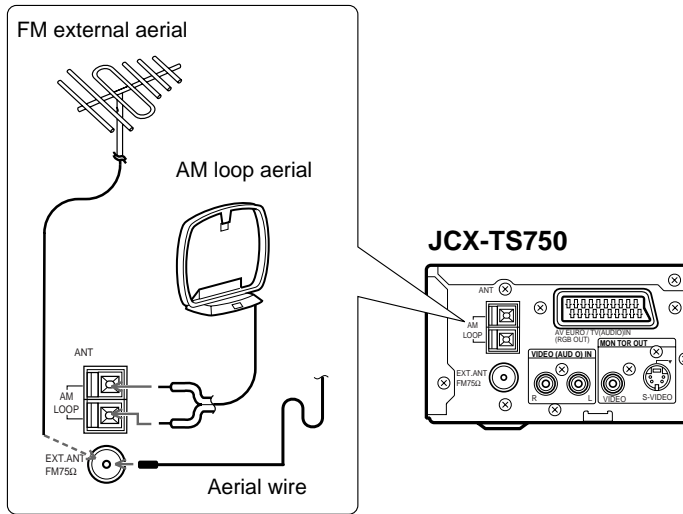

In areas close to a transmitter the simple indoor aerial is sufficient to receive broadcasts. Extend the aerial wire as straight as possible and, while listening to the sound from the system, secure it in a position which yields minimal distortion and noise.

In fringe areas or where reception is distorted or noisy, an FM external aerial (not supplied) should be connected instead of the simple indoor aerial. Consult your dealer.

## AM loop aerial

Assemble the loop aerial.

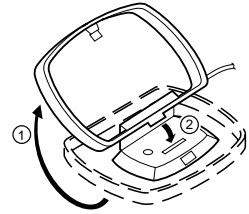

Unwind the aerial wires, then connect them to the AM LOOP terminals. Place the loop aerial in a position which yields the best AM reception, or attach it to a wall or other surface.

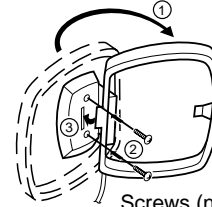

Screws (not supplied)

## Note:

To minimize noise, the speaker, mains and any other leads should not come close to the indoor or external aerial lead and AM loop aerial. Do not place the aerial leads close to the system.

## Connecting to a TV with the video lead

Connect the video lead between the MONITOR OUT VIDEO socket of the unit and the video input socket of the TV.

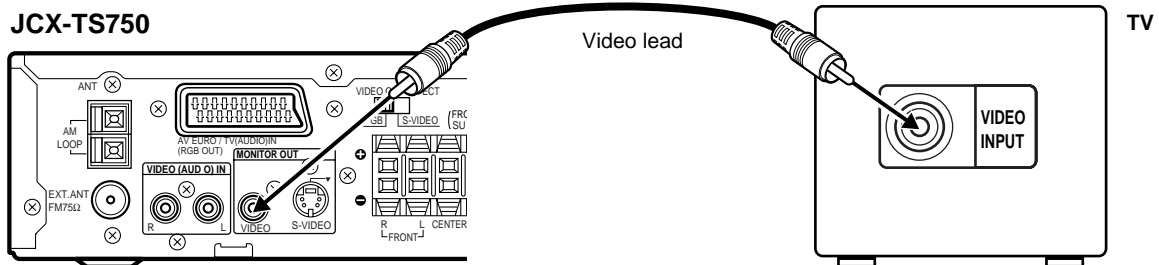

## Notes on connections

- Please refer to the instruction manuals for the components that you are connecting (TV, VCR, etc.).
- When you connect the unit to your TV and other equipment, be sure to turn off the power and disconnect all of the equipments from the AC outlet until all the connections have been made.
- **Do not connect the MONITOR OUT (S-VIDEO/VIDEO) and AV EURO/TV (AUDIO) IN (RGB OUT) sockets of the unit to a VCR directly. The playback picture will be distorted because DVD discs are copy protected.**
- Please consult your local audio/video dealer for more details.

# ADDITIONAL CONNECTIONS EXAMPLES

## Connecting to a TV with an S-video lead

Please follow these steps before turning on the power.

1. If your TV has an S-video input socket, connect the unit as shown in figure. (The MONITOR OUT VIDEO socket connection is not necessary.) You can enjoy clearer picture playback.
2. Set the VIDEO OUT SELECT switch to S-VIDEO.

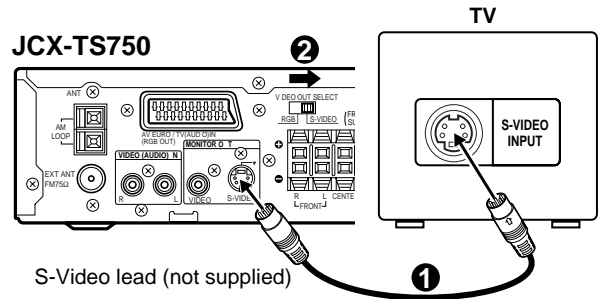

## Connecting to a TV with an EURO-AV/SCART lead

Please follow the steps below before turning on the power.

1. If your TV has an EURO-AV/SCART socket, connect the unit as shown. (Do not connect the video lead to the MONITOR OUT VIDEO socket.) You can enjoy high quality picture playback.
2. Set the VIDEO OUT SELECT switch to RGB.

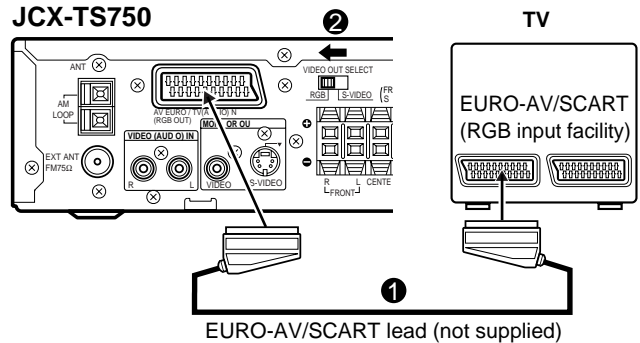

## TV or Audio equipment connections

Connect an audio lead between the VIDEO (AUDIO) IN socket of the unit and the audio output socket of the TV or audio equipment.

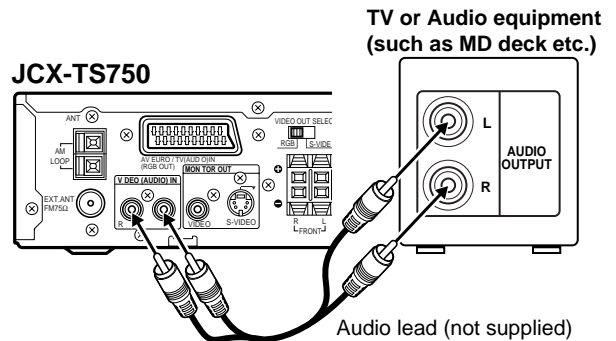

## Headphones

Connect stereo headphones (not supplied) to the PHONES socket for monitoring or for private listening. The speakers are automatically disconnected when headphones are connected.

Manufactured under license from Dolby Laboratories.

"Dolby", "Pro Logic" and the double-D symbol are trademarks of Dolby Laboratories.

DVD disc with DTS may not work correctly. You can see the picture on the TV screen, but there is no sound.

"DTS" and "DTS Digital Out" are trademarks of Digital Theater Systems, Inc.



# SYSTEM CONNECTIONS EXAMPLES

## JCX-TS750, TV and Audio equipment

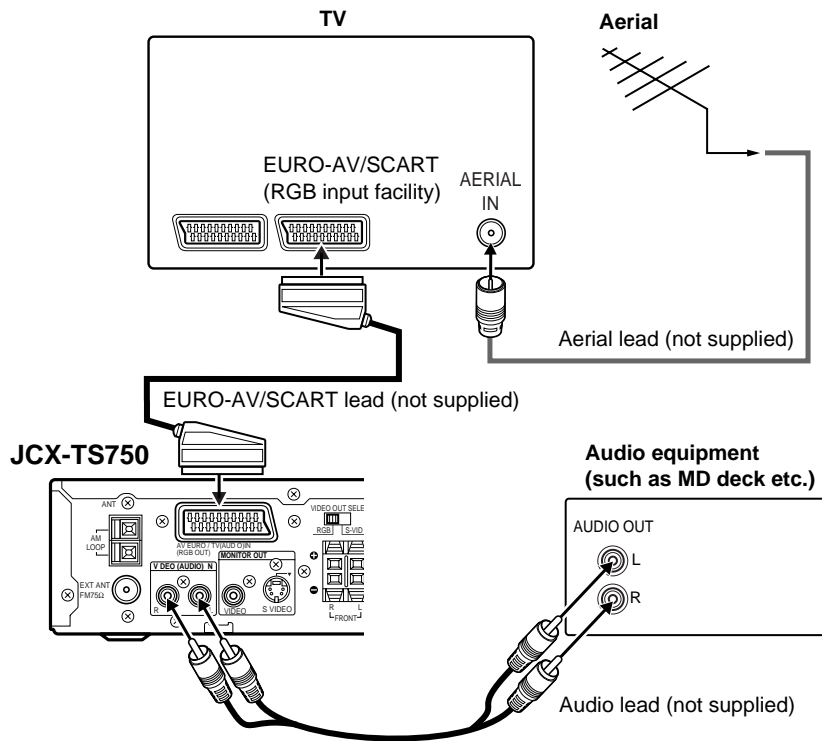

## JCX-TS750, TV and VCR

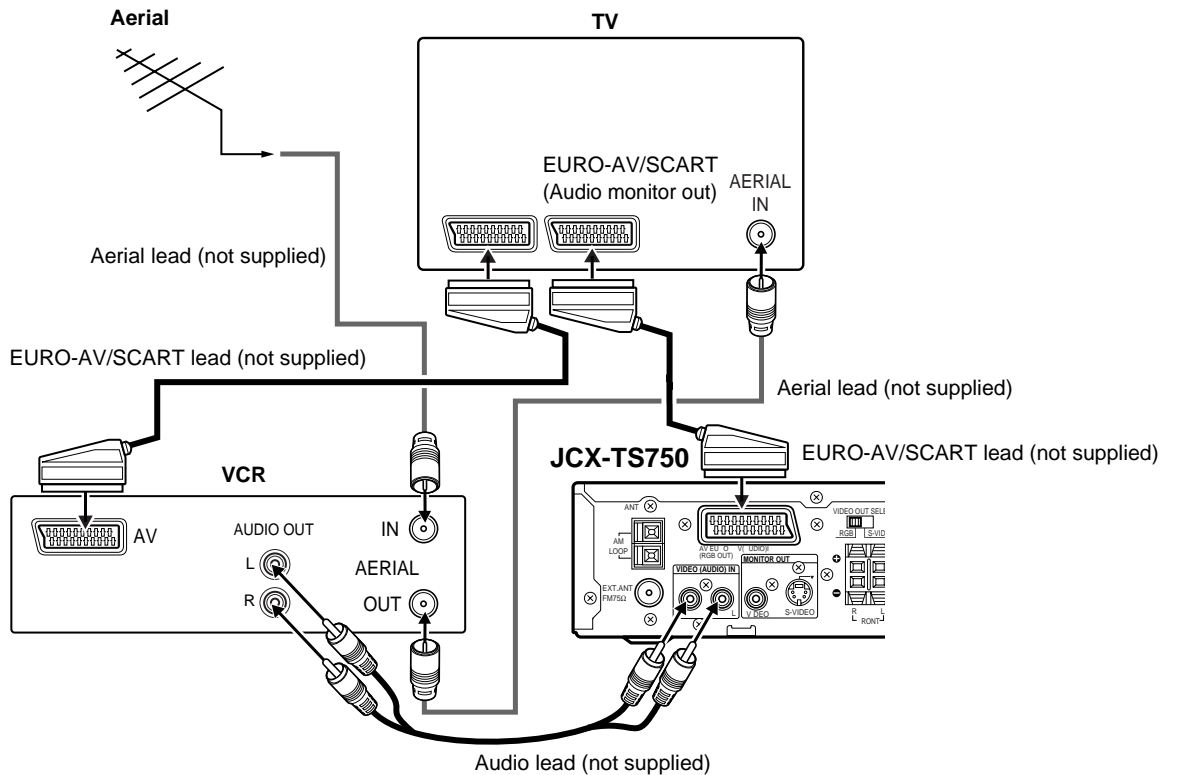

### JCX-TS750, TV, VCR and Audio equipment

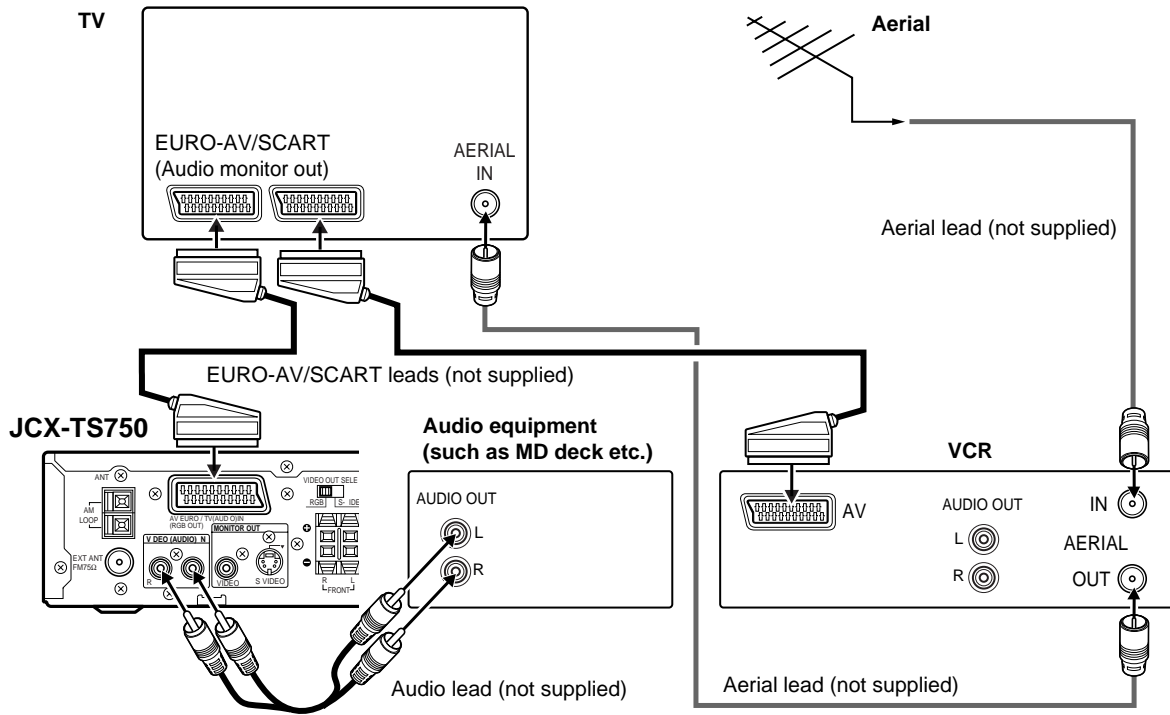

### JCX-TS750, TV, VCR, STB and Audio equipment

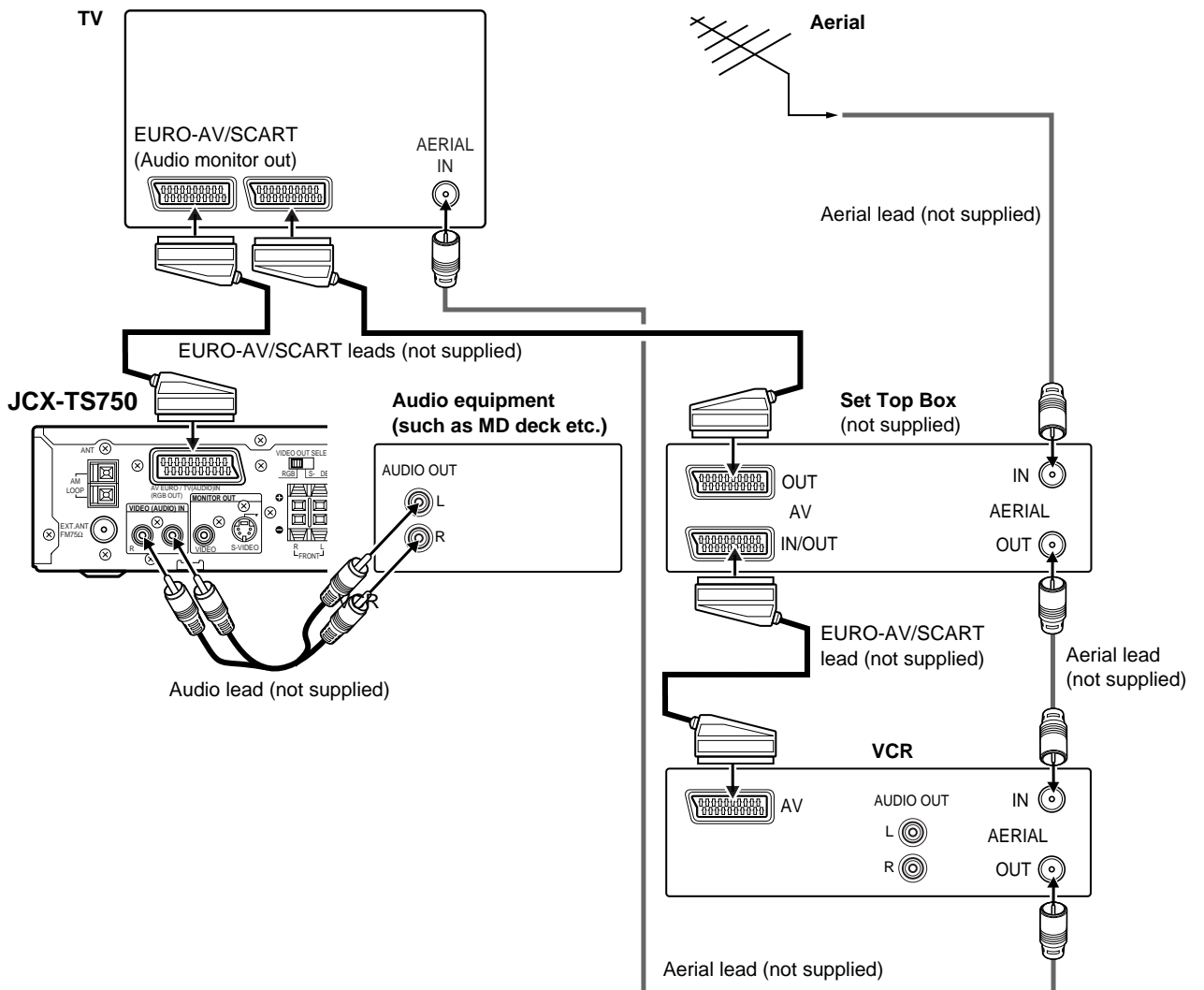

**This instruction manual explains the various functions of this unit using the remote control.**  
**The buttons on the main unit perform similar functions to similarly marked buttons on the remote control.**

## BEFORE OPERATION

### Turning the power on and off

Press the  $\odot$ /ON button. The STANDBY indicator goes out. (After connecting the mains lead, when you press the  $\odot$ /ON button for the first time, the volume-reset feature automatically sets the initial volume level.)

To turn the power off, press the  $\odot$ /ON button again. The STANDBY indicator lights.

- When the mains lead is connected to the AC outlet, the unit will respond to commands from the remote control.

### Ecology (low power consumption) standby mode

#### (Main unit only)

You can set the unit to the ecology standby mode.

First press the  $\odot$ /ON button to turn the power off, then press the  $\blacksquare$  button. Each time the button is pressed, the display changes as follows.

Clock  $\longleftrightarrow$  Off

Clock:

When turning the power off, the clock display remains lit (Ecology standby mode – off).

Off (Ecology standby mode):

When turning the power off, no display appears on the display.

### Direct start function

If the following buttons are pressed when the unit is in standby, the unit turns on automatically and the selected function is activated.

Remote control  $\blacktriangleright$ , TUNE/BAND, OPEN/CLOSE

Main unit  $\blacktriangleright$ ,  $\blacktriangle$

### Selecting the function

Press the FUNCTION button to select the desired function. Each time the button is pressed, the display changes as follows:

DVD/CD  $\rightarrow$  TV  $\rightarrow$  VIDEO  $\rightarrow$  FM TUNER  $\rightarrow$  AM TUNER  $\rightarrow$  . . .

- When the function selection is changed, disc play is automatically stopped.

### Adjusting the volume

Press the + or – VOLUME button (or turn the VOLUME control on the main unit). The volume level appears on the display (VOL 0 ~ VOL MAX).

### To reduce the volume temporarily

Press the MUTE button. "MUTE" blinks on the display. To restore the previous volume setting, press the MUTE button again.

### Bass boost system

Press the BASS button to select the desired bass boost effect.

BOOST  $\rightarrow$  BASS OFF  $\rightarrow$  NORMAL . . .

### Selecting the sound mode

1. Press the SOUND button to select the desired sound mode ("BASS" or "TREBLE").
  2. Press the  $\blacktriangle$  or  $\blacktriangledown$  button to adjust the sound level ("+5" ~ "-5").
  3. Press the SOUND button repeatedly to close the display.
- To reset "BASS" and "TREBLE" to "0", press the SOUND button to select "FLAT". Then press the ENTER button. "- - FLAT - -" briefly appears.

### Adjusting the display brightness

While pressing the  $\blacksquare$  button on the main unit, press the ON SCREEN button on the remote control.

DIMMER 1  $\rightarrow$  DIMMER 2  $\rightarrow$  DIMMER 0 . . .

### WHAT TO DO IF...

- If the operation of the unit or display is not normal,
1. Disconnect the mains lead.
  2. Press the RESET button (bottom of the main unit) for at least 30 seconds as shown in figure.
  3. Connect the mains lead.
  4. Resume operation.

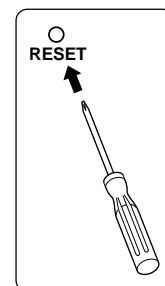

## ADJUSTING THE CLOCK

### Example: To set "6:30"

1. Press the  $\odot$ /ON button to turn the power on.
2. Press the SHIFT + 0 CLOCK buttons. "0:00" blinks.
3. Press the SHIFT + 8 ADJUST buttons within 10 seconds.

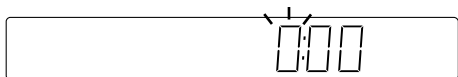

The hours display blinks.

4. Press the  $\blacktriangleright$  or  $\blacktriangleleft$  button to set the "hours".

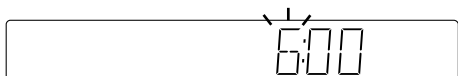

5. Press the SHIFT + 8 ADJUST buttons.



The minutes display blinks.

6. Press the  $\blacktriangleright$  or  $\blacktriangleleft$  button to set the "minutes".

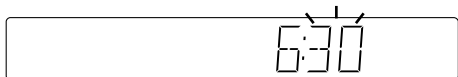

7. Press the SHIFT + 8 ADJUST buttons. The clock starts.



- The time can be set accurately by pressing the SHIFT + 8 ADJUST buttons when a time signal is heard.

### To display the clock during operation

Press the SHIFT + 0 CLOCK buttons. Press both buttons again to return to the original display.

Note:

When the display blinks because of a power failure, reset the time.

### Changing the clock to the 12-hour display (Main unit only)

1. Press the  $\odot$ /ON button to turn the power off. (If the clock is not displayed, press the  $\blacksquare$  button to display the clock.)
2. While pressing the FUNCTION button, press the  $\blacksquare$  button.

Example: 13:00  $\rightarrow$  PM 1:00

To return the original setting, repeat steps above.

# VARIOUS ADJUSTING

## Selecting surround mode

Press the SURROUND button to select the surround mode. Each time the button is pressed, the surround mode changes as follows:

AUTO → SURR ON → 2CH MODE → AUTO . . .

### When “DVD/CD” function is selected

#### AUTO

The unit selects the surround mode automatically depending on the disc.

#### Dolby Digital (not encoded with Dolby Surround sound)

“DOLBY DIGITAL” appears on the display.

Dolby Digital is a discrete 5.1 channel surround system, developed for cinema use. But, not all Dolby Digital sources are recorded with 6 channel.

Some sources marked Dolby Digital may be recorded in Dolby Surround, a 2 channel system.

#### Dolby Digital (encoded with Dolby Surround sound)

“DOLBY DIGITAL” and “DOLBY PL” appear on the display.

The surround mode is set to Dolby Pro Logic mode.

Dolby Pro Logic is a decoding system that was developed to enhance the soundtracks of the theatrical motion pictures with Dolby Surround. All speakers sound, but the surround left and right speakers are monophonic sound.

#### Other (PCM, CD, MP3, etc.)

The surround mode is set to 2.1 channel (Front left and right speakers, and subwoofer).

#### SURR ON

When using a disc with Dolby Digital 3 ~ 5.1 channel, it is set to Dolby Surround mode.

When using an MP3 CD, it is set to matrix-surround mode (not Dolby Pro Logic).

Other discs are set to Dolby Pro Logic mode.

#### 2CH MODE

The surround mode is set to 2.1 channel (Front left and right speakers, and subwoofer).

### When “TV”, “VIDEO”, “FM TUNER” or “AM TUNER” function is selected

#### AUTO

It is set to 2.1 channel (Front left and right speakers, and subwoofer).

#### SURR ON

All speakers work, but it is set to the matrix-surround mode (not Dolby Pro Logic).

If a monaural source is used, it is set to 3.1 channel (Front left and right, centre speakers, and subwoofer).

#### 2CH MODE

It is set to 2.1 channel (Front left and right speakers, and subwoofer).

#### Note:

- There is no Dolby Surround effect when monaural programme material is used.
- When receiving weak FM broadcasts, set it to “2CH MODE”. The sound quality may improve.
- When headphones are connected while any of the surround modes are selected, the surround mode is switched off automatically. The SURROUND button does not function while headphones are connected.

## Adjusting the speaker volume balance

This unit is set to the standard level before shipping from the factory. You may not need adjustment.

But, depending on the size of the room and the placement of the speakers, you may need a fine adjustment.

In this case, follow the steps below. Please use the remote control at the listening point.

1. Press the FUNCTION button to select the “DVD/CD”.
2. Press the ■ button to stop play completely.
3. Press the TEST button. The speaker screen appears. “FNTR 0” appears on the display.

The test tone will be heard from each speaker sequentially as follows:

TV screen	Display	Speaker
Front-L	FNTR 0	Front left speaker
Center	CENT 0	Centre speaker
Front-R	FNTR 0	Front right speaker
Surround-R	SURR 0	Surround right speaker
Surround-L	SURL 0	Surround left speaker

4. Press the + or – VOLUME button until the test tone is at a comfortable level.
5. If the test tone level is not the same from each speaker, press the ▼ or ▲ button to adjust it while the speaker is active. The level appears on the display.

FNTR/FNTR: “0” ~ “-10”

CENT/SURR/SURL: “+10” ~ “-10”

If necessary, repeat this step again.

6. Press the TEST button to turn the test tone off.

#### Note:

If no adjustments are made, the original display returns after the test tone has cycled round 5 times.

7. Press the + or – VOLUME button to adjust the volume.

## Adjusting the subwoofer level

1. Press the SHIFT + TRIM buttons. “FNTR 0” appears on the display. Note: No test tone.

2. Press the ENTER button repeatedly to select “SUBW”. Each time the button is pressed, the display shows the selected speaker and tone level.
3. Press the ▼ or ▲ button to adjust the level as desired.

SUBW: “+10” ~ “-10”

#### Note:

If another speaker is selected, the level also can be changed as above.

4. Press the SHIFT + TRIM buttons to turn it off.



#### Note:

If no adjustments are made, the original display returns after approximately 10 seconds.

Set the delay time for your centre and surround speakers. See “Setting audio” on page 19.

# PLAYABLE DISCS

The following types of discs can be played on this unit.

Disc type and logo mark		Recorded content	Disc size	Maximum playing time
DVD Video		Audio + Video	12 cm	Approx. 4 hours (Single sided disc) Approx. 8 hours (Double sided disc)
			8 cm	Approx. 80 minutes (Single sided disc) Approx. 160 minutes (Double sided disc)
Music CD		Audio	12 cm	74 minutes
			8 cm	20 minutes

## Region number

Region number (Regional restriction code) is built-in to the unit and DVD discs.

There is a region number on the rear of the unit.

The same region number or region number "ALL" of DVD discs can be used on this unit.

## DVD disc

There are the marks on some DVD disc packages.

Example:



Multiple Languages



Multi-language subtitles



Multi-angle



Multi-aspect



Region number



Closed caption

DVD discs are divided into titles, and the titles are sub-divided into chapters.

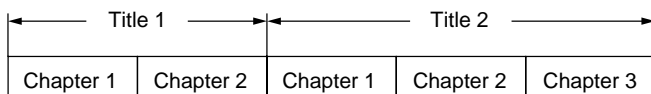

## Music CD disc

Music CD discs are divided into tracks.

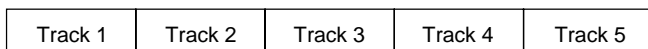

## Note:

- Only the above types of discs can be played on this unit. DVD-ROM, CD-ROM, SVCD, VCD, CVD, etc. cannot be played.
- This unit can play back the CD-R/RW that has recorded music data or MP3 files. However, some CD-R/RWs can not be played back depending on the recording conditions.
- The CD-R/RW that has no music data or non-MP3 files can not be played back.
- This unit can play back the DVD-R that has recorded movie data. However, some DVD-Rs can not be played back depending on the recording conditions.
- The DVD-R that has no movie data can not be played back.
- This unit is to be used exclusively with the PAL (or NTSC) colour system discs. SECAM system discs cannot be used with this unit.
- The video output signal format can be selected ("PAL60" or "NTSC") when playing back the NTSC discs.

## Notes on handling discs

- Do not expose the disc to direct sunlight, high humidity or high temperatures for extended periods of time.
- Discs should be returned to their cases after use.
- Do not apply paper or write anything on the disc surface.
- Handle the disc by its edge. Do not touch the playing surface (glossy side).
- Fingerprints and dust should be carefully wiped off the playing surface of the disc with a soft cloth. Wipe in a straight motion from the centre to the outside of the disc.
- Never use chemicals such as record cleaning sprays, antistatic sprays or fluids, benzene or thinner to clean discs.

# DISC PLAY

## Important note:

- This "DISC PLAY" explains the basic instruction of the DVD player section.
- Some DVD discs have different functions that may not be explained in this instruction manual. You may need extra instructions. In this case, please follow the instructions displayed on the TV screen or jacket or case of the disc.
- "⊘" may appear on the TV screen during operation. This icon means that the function is not available on the disc now.

## Preparations

- Turn on the TV and select the video input for this unit.

### To use the remote control for TV

The remote control must be pointed toward your TV.

1. Press the TV POWER button to turn on the power.
2. Press the TV/VIDEO button to select the video input source.

Select the playback picture size according to the aspect ratio of the TV. (See "Setting display" under "INITIAL SETTINGS" on Page 18.)

- Select the desired language for the on-screen menus if required. The following languages can be selected.  
English, Spanish, French, German, Portuguese  
(See "Setting language" under "INITIAL SETTINGS" on Page 18.)

### Note:

- Do not touch the disc tray while it is moving.
- Never place anything except a disc on the disc tray. Foreign objects can damage the unit.
- Do not apply excessive force to the disc tray.
- Only one disc must be placed on the disc tray at a time.
- To open or close the disc tray, be sure to use the OPEN/CLOSE (or ▲ on the main unit) button. Do not press the disc tray with your hand.

**When operation buttons are pressed, that operation is displayed on the TV screen for several seconds.**

If a disc is loaded, you can turn the unit on and begin play immediately by pressing the ► button.

1. Press the OPEN/CLOSE button. "OPEN" appears on the display and the disc tray opens. "SANYO" logo appears on the TV screen.
  - When using the main unit, use the ▲ button.
2. Place the disc with the label facing up on the disc tray.

### 12 cm disc

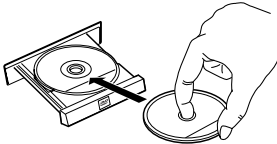

### 8 cm disc

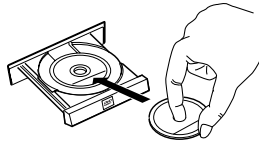

3. Press the OPEN/CLOSE button again.
  - The disc tray closes and "READING" appears on the display.

### Note:

Some discs may start play automatically.

## Starting play

Press the ► button. The DVD/CD function is selected and play starts automatically.

Example:

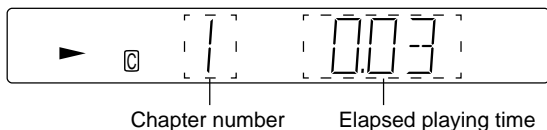

### Note:

If "NO DISC" appears on the display, load the disc.

- If the disc is loaded with the label side downward (and it is a single sided disc), or if a badly scratched disc is loaded, "NO DISC" (or "NO PLAY") appears. If this occurs, load the disc correctly or replace the disc.

## If a menu appears on the TV screen...

Press the ▲, ►, ▼ or ◀ button (or the number buttons), then press the ENTER button to select the desired menu.

Playback of the selected menu starts.

### Note:

For more details, please refer to the jacket or case of the disc.

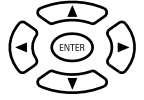

## Stopping play

### [DVD]

- Press the ■ button once.  
When you press the ► button, play starts automatically from the point where you stopped.

### Note:

Some discs may not resume play.

- Press the ■ button twice. The unit stops completely and "STOP" appears on the display.

When you press the ► button, play starts from the beginning of the disc.

### [CD]

- Press the ■ button. The unit stops completely.

## Continuing play from where you stopped watching (LAST MEMORY PLAY) [DVD]

1. During play, press the L.MEMO button at the point from which you want to resume play later. "LM-STOP" appears on the display. Play stops automatically.
2. Remove the disc or turn off the power.
3. Load the disc (and press the ► button), or turn on the power. "Last Memory Play?" screen appears.

Last Memory Play?

Yes

No

Clear      (The memory is released.)

4. Press the ▲ button to select "Yes".
5. Press the ENTER button. Play resumes from the point where you stopped. (If desired, press the L.MEMO button again.)

### Note:

- Points on up to 3 discs can be memorized.
- The Last Memory Play mode may not work correctly with some discs.

## To lock the disc tray

You can lock the disc tray to prevent misuse by young children.

While the disc tray is opened, press the OPEN/CLOSE button until "LOCKED" appears on the display. (The disc tray closes.)

- The OPEN/CLOSE button will not function.

To release this mode, press the OPEN/CLOSE button until "UNLOCKED" appears on the display.

# VARIOUS DISC PLAYING FUNCTIONS

"⊘" may appear on the TV screen during operation. This icon means that the function is not available on the disc now.

## Selecting a DVD menu [DVD]

1. Press the MENU button. The main menu screen appears.  
Note:  
Press the MENU button again to resume play.
2. Press the ▲, ▼, ◀ or ▶ button (or the number buttons) to select the desired menu, then press the ENTER button. The selected menu play starts.

## Selecting a title menu [DVD]

1. Press the TITLE button. The title menu appears.
2. Press the ▲, ▼, ◀ or ▶ button (or the number buttons) to select the desired title, then press the ENTER button. The selected title play starts.

Note:

Selecting a DVD or title menu operation may differ depending on the disc used and may not be possible on some discs.

## Chapter (Track) skip



### Skipping forward

Press the ►► button during play to skip to the next chapter (or track). A chapter (or track) is skipped each time the button is pressed.

### Skipping backward

Press the ◀◀ button during play to skip back to the beginning of the chapter (or track) currently play. Press the button again immediately to skip back to the beginning of the previous chapter (or track).

Note:

You can skip only through the chapters, not over the title on the DVD disc.

## Title search [DVD]

1. Press the SHIFT + SEARCH MODE buttons once during play or in the stop mode. The title search screen appears.

Example:

Title Search --/02

2. Press the number button(s) to enter the title number.

Example:

To select No. 3, press 0, then 3 (or press 3).

To select No. 10, press 1, then 0.

To select No. 24, press 2, then 4.

- If you make a mistake, press the CLEAR button.

3. Press the ► button. Play starts from the selected title.

## Chapter search [DVD]

1. Press the SHIFT + SEARCH MODE buttons twice during play. The chapter search screen appears.

Example:

Title 01 Chapter Search --/35

2. Press the number button(s) to enter the chapter number.

3. Press the ► button. Play starts from the selected chapter.

## Track search [CD]

Press the number button(s) during play or in the stop mode, then press the ► button. Play starts from the selected track.

## Time search

### [DVD]

1. Press the SHIFT + SEARCH MODE buttons three times during play. The time search screen appears.

Example:

Time Search --:--:--

2. Press the number button(s) to enter the time.

Example:

20 minutes 5 seconds

Press 2, 0, 0 then 5.

1 hour 4 minutes 35 seconds

Press 1, 0, 4, 3 then 5.

- If you make a mistake, press the CLEAR button.

3. Press the ► button. Play starts from the searched time.

### [CD]

1. Press the SHIFT + SEARCH MODE buttons once during play. The time search screen appears.

2. Press the number button(s) to enter the time.

3. Press the ► button. Play starts from the searched time in the track.

## Fast play

Press the ►► or ◀◀ button repeatedly to select the fast speed forward or reverse play.

### [DVD]

"►► 1", "►► 2", "►► 3", "►► 4" or "◀◀ 1", "◀◀ 2", "◀◀ 3", "◀◀ 4"

### [CD]

"►► 1", "►► 2" or "◀◀ 1", "◀◀ 2"

Press the ► button to return to normal play.

## Slow-motion play [DVD]

Press the F.SLOW ► or R.SLOW ◀ button repeatedly to select the forward or reverse slow speed play.

"► 1", "► 2", "► 3", "► 4" or "◀ 1", "◀ 2", "◀ 3", "◀ 4"

Press the ► button to return to normal play.

Note:

The sound is muted during fast play or slow-motion play in DVD.

## Still picture (Pause)

[DVD]: Still picture mode, [CD]: Pause mode

Press the || button during play.

Press the ► button to return to normal play.

Note: The sound is muted.

## Frame by frame advance play [DVD]

Press the || button during still play. Each time the button is pressed, the picture advances one frame.

Press the ► button to return to normal play.

Note:

- The sound is muted.

- Frame play is operative in forward mode only.

## Picture zoom [DVD]

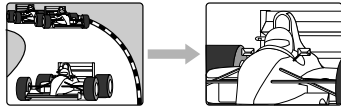

- Press the SHIFT + 3 ZOOM buttons during normal, slow or still play. The central part of the picture is magnified.
  - Each time the button is pressed, the zoom mode changes as follows.  
 $Q\ 1 \rightarrow Q\ 2 \rightarrow Q\ Off$
  - Press the ▲, ►, ▼ or ◀ button to change the zoom point.
- Press the SHIFT + 3 ZOOM buttons to select "Q Off" to return to the original screen.

Note:  
Picture zoom may not work on some discs.

## Viewing from a desired camera angle (Multi-Angle) [DVD]

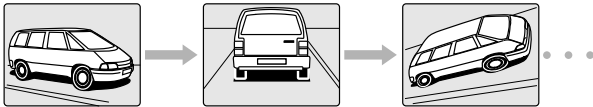

Some DVD discs may contain scenes which have been shot simultaneously from a number of different camera angles. The jacket or case of discs that are recorded with angles will be marked.

Example:



Note: The recorded angles differ depending on the disc used.

- Play the disc that is recorded with angles.
- Press the SHIFT + 1 ANGLE buttons repeatedly until the desired angle appears.

Example:



## Angle replay [DVD]

During Multi-angle play screen, press the SHIFT + 2 A.REPLAY buttons. The unit skips back to last approximately 10 seconds, changes it to the next camera angle and plays it, and continues play. (If desired, press the button again.)

## Repeat play

Press the REPEAT button during play (or programmed play) of the title (or track) you want to repeat. Each time the button is pressed, the repeat mode changes as follows.

### [DVD]

- Chapter (1 REP.): Repeat of chapter being played
- Title (ALL REP.): Repeat of title being played
- Off: Normal play mode

### [CD]

- 1 (1 REP.): Repeat of track being played
- All (ALL REP.): Repeat all tracks
- Off: Normal play mode

## Designated range repeat play (A-B Repeat)



- Press the A-B REP button during play at the beginning of the section you want to repeat (Point A). "A-" appears on the screen. "A-REP." blinks on the display.
- Press the A-B REP button again at the end of the section (Point B). "A-B REP." remains lit on the display. The section between points A and B is played repeatedly.
- To return to normal play, press the A-B REP button again.

Note:  
Repeat play or A-B repeat play mode may not work correctly with some discs.

## Programmed play [CD]

Up to 20 selections can be programmed.

### Programming procedure

- Press the PROGRAM button when in the stop mode. The programme mode screen appears. (A simple screen appears in the display on the player and a more in-depth screen appears on the TV screen).
- Press the number button(s) to select the track number.  
Example:  
To select track No.3, press 0, then 3 (or press 3).  
To select track No.10, press 1, then 0.  
To select track No.24, press 2, then 4.  
Note:  
If you make a mistake, press the CLEAR button.
- Press the ▼ button to move the highlighted box down.

Example as seen on your TV screen.

### Program Mode

#### All Clear

1	03	6 --	11 --	16 --
2	--	7 --	12 --	17 --
3	--	8 --	13 --	18 --
4	--	9 --	14 --	19 --
5	--	10 --	15 --	20 --

- Repeat step 2 - 3 above to select another track.
- Press the ► button to start play. "PROG." remains lit.  
When all programmed selections have played, the unit stops automatically.
  - The programme contents are retained in memory.

Note:

To play the programme again, press the PROGRAM button to call up the programme mode screen, then press the ► button.

### To clear the programme one by one

In the programming mode, press the ▲ or ▼ button to select the track number. Then press the CLEAR button.

### To clear all the programmes

In the programming mode, press the ▲ button to select "All Clear". Then press the ENTER button.

### To change the programme

- In the programming mode, press the ▲ or ▼ button to select the programme number.
- Press the number button(s) to select the track number to be replaced.

Press the PROGRAM button to quit the programme mode screen.



## Selecting subtitle language [DVD]

This operation works only with discs on which multiple subtitle languages are recorded.

1. Press the S.T.ON/OFF button during play. "☐" appears on the screen.
2. Press the S.T.CH button repeatedly until the desired subtitle language appears on the screen.

Example:

☐ 1/3 fr (French)

After few seconds, "☐" disappears.

Note:

- In some cases, the subtitle language is not changed to the selected one.
- When a disc supporting closed caption is played, the subtitle and the closed caption may overlap each other on the TV screen. In this case, turn the subtitle off.
- When the desired language is not selected even if the button is pressed, the language is not available on the disc.
- When the power is turned on or the disc is replaced, select the subtitle language again.
- If the subtitle language is not necessary, press the S.T.ON/OFF button to select "☐ Off".

## Selecting audio soundtrack language (Multi-Language) [DVD]



This operation works only with discs on which multiple audio soundtrack languages are recorded.

1. Press the SHIFT + 5 AUDIO buttons during play.
2. Press the SHIFT + 5 AUDIO buttons repeatedly until the desired language appears on the screen.

Example:

☐ 1/4 fr (French)

☐ 1/3 DTS (DTS sound)

- If using a DVD disc with DTS, "DTS" appears. You can see the picture on the TV screen, but there is no sound.

Note:

- When the desired language is not selected even if the button is pressed, the language is not available on the disc.
- When the power is turned on or the disc is replaced, select the language again.
- If the language is not recorded on the disc, only the available language on the disc will be heard.

## Selecting on-screen information

Press the ON SCREEN button repeatedly to show the disc information (Title, Chapter, Title elapsed playing time, Language, etc.).

Example for DVD:

1. Press the ON SCREEN button during play.

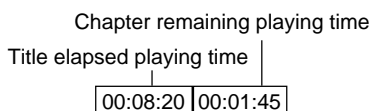

2. Press the ON SCREEN button.

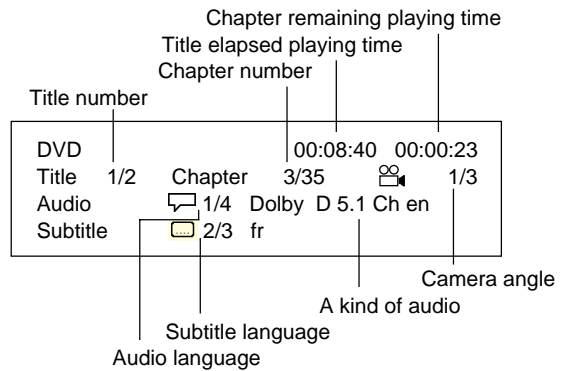

3. Press the ON SCREEN button to close the disc information.

Example for music CD:

1. Press the ON SCREEN button during play.

Track elapsed playing time

02:25

2. Press the ON SCREEN button.

Track elapsed playing time



3. Press the ON SCREEN button to close the disc information.

## Selecting picture mode

Press the PICTURE MODE button. Each time the button is pressed, the picture mode changes as follows:

Standard → Mild → Black and White → Standard ...

# MP3 CD OPERATION

This unit can play back the CD-R/RW that have recorded music data or MP3 files. Before playing back MP3 CD, please read the following.

## MP3 CD information

### Limitations on MP3 CD play

- MP3 CD is the disc that standardized by ISO9660 Level 2.
- This unit can recognize up to 200 files or folders per disc. The CD with 201 files or folders and over is not available to this unit.
- MP3 CD may not be played in the recorded order.
- As for multi-session disc, only the first session can be played.
- If the CD has both audio tracks and MP3 files, only audio tracks are played.
- It would take 30 seconds or more for this unit to read MP3 files depending on its structure.

### Limitations on display

- The maximum number for directory name is approximately 8 letters.
- The maximum number for file name is approximately 10 letters.
- Available letters for display are the following: capital or small letters of A through Z, and numbers of 0 through 9.
- Other letters than those above are replaced in "-" (hyphen).

### Notes on MP3 files

- The recommend recording setting for a high-quality sound is 44.1 kHz of sampling frequency and 128kbps of fixing bit rate.
- To play MP3 CD in the recorded order,
  1. Please use the MP3 software with the function that can record data alphabetically or numerically.
  2. Please refrain from making many sub-folders by preference.
- Some MP3 CDs can not be played back depending on the recording conditions.

## MP3 CD play

1. Load the MP3 CD.  
A table of contents in the root directory appears on the screen.

Example: (the root directory)

MP3	HYPE-AX	-/24	00:00:00
1	MUSIC001	8	MUSIC008
2	MUSIC002	9	MUSIC009
3	MUSIC003	10	MUSIC010
4	MUSIC004	11	MUSIC011
5	MUSIC005	12	MUSIC012
6	MUSIC006		
7	MUSIC007		

2. Select the desired file by pressing the ▲, ►, ▼ or ◀ button. The selected file number is highlighted.
  - To go on to the next directory, press the ▲ button to move the highlighted box to the folder (Example: HYPE-AX), then press the ENTER button.  
A table of contents in the selected directory appears on the screen.
  - To go back to the previous directory, press the RETURN button.
  - In some discs, if the MENU button is pressed, it goes back to the root directory.

3. Press the ► button to start play.  
Current file number, total file number and current file elapsed playing time are displayed on the screen.

Example: (the second directory)

MP3	MAX2	13/24	00:00:08
13	MUSIC013	20	MUSIC020
14	MUSIC014	21	MUSIC021
15	MUSIC015	22	MUSIC022
16	MUSIC016	23	MUSIC023
17	MUSIC017	24	MUSIC024
18	MUSIC018		
19	MUSIC019		

### Notes on file skip

Skipping forward

Press the ►| button during play to skip to the next file.

Skipping backward

Press the ◀◀ button during play to skip back to the beginning of the file currently play. Press the button again immediately to skip back to the beginning of the previous file.

### Notes on repeat play

Press the REPEAT button during play.

Each time the button is pressed, the repeat mode changes as follows.

↺ 1 (1 REP.): Repeat of file being played

↺ All (ALL REP.): Repeat all files

↺ Off: Normal play mode

Note:

Repeat play may not work correctly with some discs.

# INITIAL SETTINGS

Once the initial settings have been completed, the unit can always be operated under the same conditions. The settings will be retained in the memory until they are changed, even if the power is turned off.

## Setting language

1. Press the SETUP button in the stop mode. The setup screen appears and "Language" is highlighted.
2. Press the ENTER button. "Language" screen appears.
3. Press the ▼ or ▲ button to select the item (highlighted).

Example:

OSD	English
Audio	Disc
Subtitle	Disc
DVD Menu	Disc

4. Press the ENTER button. The submenu appears.

Example:

OSD	English	English
Audio	Disc	Español
Subtitle	Disc	Français
DVD Menu	Disc	Deutsch
		Portugues

5. Press the ▼ or ▲ button to select the language (highlighted).
6. Press the ENTER button. The selected language remains.
7. Repeat steps 3 - 6 for other items.

Note:

If "Others" is selected, enter the language code. (See "LANGUAGE CODE LIST" on page 20.)

8. Press the ▲ button to skip back to the setup screen (or press the SETUP button to quit the setup screen).

Note:

- You cannot switch audio sound track languages if there is only one language recorded on the disc.
- When you play a DVD disc, the unit automatically displays the pre-selected subtitle language if it is included on the disc.
- **For improvement, on-screen displays subject to change without notice.**

## Setting display

1. Press the SETUP button in the stop mode. The setup screen appears.
2. Press the ► button to select "Display", then press the ENTER button. "Display" screen appears.
3. Press the ▼ or ▲ button to select the item (highlighted), then press the ENTER button. The submenu appears.

Example:

TV Type	4:3 LB	4:3 LB
NTSC Disc	PAL60	4:3 PS
		16:9

4. Press the ▼ or ▲ button to select the submenu (highlighted).

Example: To select "TV Type: 4:3 PS"

TV Type	4:3 LB	4:3 LB
NTSC Disc	PAL60	4:3 PS
		16:9

5. Press the ENTER button. (In this example, "TV Type: 4:3 PS" remains.)
6. Repeat steps 3 - 5 for other items.
7. Press the ▲ button to skip back to the setup screen (or press the SETUP button).

### TV Type:

#### 4:3 LB (Letterbox):

Select when a conventional TV set is connected. When the wide screen disc is played back, the black bands appear at the top and bottom of screen.



#### 4:3 PS (Panscan):

Select when a conventional TV set is connected. When the wide screen disc is played back, it displays pictures cropped to fill your TV screen. The left and right edges are cut off.

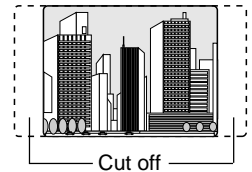

#### 16:9 :

Select when a wide screen TV set is connected. Played in "FULL" size. (Setting the wide screen TV to "FULL" mode is also necessary.)



Note:

- The screen size may differ depending on the DVD discs.
- If you select 16:9 to get rid of the black bands on screen when wide screen disc is played back, picture may be slightly distorted.
- In some discs, even if 4:3 PS is selected, the black bands may remain on the screen.

### NTSC Disc:

Select the video output signal format to "PAL60" or "NTSC" when playing back the NTSC discs.

## Setting audio

The sound from speakers can reach the listening position at different times depending on the speaker placements. You can allow for this difference by changing the delay time of the centre and surround speakers.

You also can change the dynamic range control (DRC).

1. Press the SETUP button in the stop mode. The setup screen appears.
2. Press the ► button to select "Audio", then press the ENTER button. "Audio" screen appears.

Example:

Audio DRC	Off
Center Delay	0ms
Surr. Delay	5ms

3. Press the ENTER button to select "Audio DRC". The submenu ("On" and "Off") appears.
4. Press the ▼ or ▲ button to select "On" or "Off" as desired.  
On: It will compress the dynamic range. It may have no effect with some discs.  
Off: Sound with a wide dynamic range.
5. Press the ENTER button. "Audio DRC: On" or "Audio DRC: Off" remains.
6. Press the ▼ button to select "Center Delay", then press the ENTER button. The submenu ("0ms", "1ms", "2ms", "3ms", "4ms" and "5ms") appears.
7. Press the ▼ or ▲ button to select the centre speaker delay time.

### Centre speaker delay time

If  $D1 \leq D2$ , set the delay time to "0ms".

If  $D1 > D2$ , set the delay time as follows:

Difference between D1 and D2	Delay time
Approx. 30cm	1ms
Approx. 60cm	2ms
Approx. 90cm	3ms
Approx. 120cm	4ms
Approx. 150cm	5ms

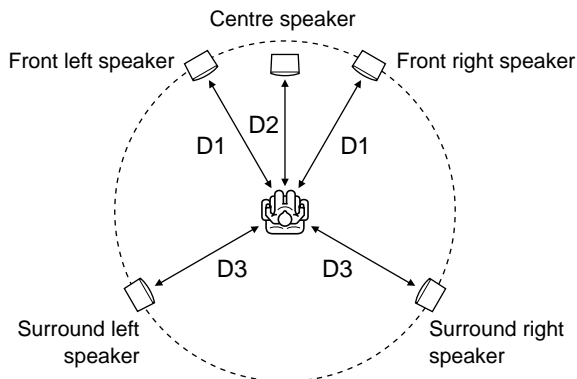

- D1: The distance from the front speaker  
 D2: The distance from the centre speaker  
 D3: The distance from the surround speaker.

8. Press the ENTER button. "Center Delay" and the selected delay time remain.
9. Press the ▼ button to select "Surr. Delay", then press the ENTER button. The submenu ("0ms", "5ms", "10ms" and "15ms") appears.
10. Press the ▼ or ▲ button to select the surround speaker delay time.

### Surround speaker delay time

If  $D1 \leq D3$ , set the delay time to "0ms".

If  $D1 > D3$ , set the delay time as follows:

Difference between D1 and D3	Delay time
Approx. 150cm	5ms
Approx. 300cm	10ms
Approx. 450cm	15ms

11. Press the ENTER button. "Surr. Delay" and the selected delay time remain.
12. Press the ▲ button to skip back to the setup screen (or press the SETUP button).

## Setting parental

1. Press the SETUP button in the stop mode. The setup screen appears.
2. Press the ► button to select "Parental", then press the ENTER button. "Parental" screen appears.
3. Press the ▼ button to skip "Password: ----" and select "Level".

Password: ----  
 Level: Off

4. Press the ENTER button repeatedly to select the parental lock level ("Level: Off, 1 ~ 8").
5. Press the ▲ button to return to "Password: ----".
6. Enter a number in 4 digits, then press the ENTER button. The password is now set.

Password: ----  
 Level: 1

Note:

If you do not set it, Parental control does not work, and it returns to the initial settings.

7. Press the SETUP button. The setup screen disappears.

### Parental control

MPAA (Motion Picture Association of America) guideline is a rating system that provides advanced cautionary information to parents about the content of movie programmes.

The parental lock level is equivalent to the following MPAA rating system.

Level 7: NC-17 (No one 17 and under admitted)

Level 6: R (Restricted)

Level 4: PG13 (Parental guidance cautioned)

Level 3: PG (Parental guidance suggested)

Level 1: G (General audiences)

Some DVD discs contain a restriction level which enables parents to prevent playback of discs by children. This unit is equipped with a password designed to prevent children changing the level.

You cannot play DVD discs rated higher than the level you selected unless you cancel the parental lock function.

For example, when you select level "5", the unit will not play discs with ratings of "6", "7" or "8". The information will appear on the TV screen.

### If you forget the password...

Enter "788444" even if 4 digits "----" appears, then press the ENTER button to clear the current password. Enter a new password and set the parental lock level again.

Note:

DVD discs may or may not respond to the parental lock settings. Make sure this function works with your DVD discs.

# LANGUAGE CODE LIST

Enter the appropriate code number for the initial settings "Audio", "Subtitle" and "DVD Menu".

Code	Abbreviation of the language	Language	Code	Abbreviation of the language	Language	Code	Abbreviation of the language	Language
6565	aa	Afar	7369	ie	Interlingue	8278	rn	Kirundi
6566	ab	Abkhazian	7375	ik	Inupiak	8279	ro	Romanian
6570	af	Afrikaans	7378	in	Indonesian	8285	ru	Russian
6577	am	Amharic	7383	is	Icelandic	8287	rw	Kinyarwanda
6582	ar	Arabic	7384	it	Italian	8365	sa	Sanskrit
6583	as	Assamese	7387	iw	Hebrew	8368	sd	Sindhi
6589	ay	Aymara	7465	ja	Japanese	8371	sg	Sangro
6590	az	Azerbaijani	7473	ji	Yiddish	8372	sh	Serbo-Croatian
6665	ba	Bashkir	7487	jw	Javanese	8373	si	Singhalese
6669	be	Byelorussian	7565	ka	Georgian	8375	sk	Slovak
6671	bg	Bulgarian	7575	kk	Kazakh	8376	sl	Slovenian
6672	bh	Bihari	7576	kl	Greenlandic	8377	sm	Samoaan
6673	bi	Bislama	7577	km	Cambodian	8378	sn	Shona
6678	bn	Bengali; Bangla	7578	kn	Kannada	8379	so	Somali
6679	bo	Tibetan	7579	ko	Korean	8381	sq	Albanian
6682	br	Breton	7583	ks	Kashmiri	8382	sr	Serbian
6765	ca	Catalan	7585	ku	Kurdish	8383	ss	Siswati
6779	co	Corsican	7589	ky	Kirghiz	8384	st	Sesotho
6783	cs	Czech	7665	la	Latin	8385	su	Sundanese
6789	cy	Welsh	7678	ln	Lingala	8386	sv	Swedish
6865	da	Danish	7679	lo	Laothian	8387	sw	Swahili
6869	de	German	7684	lt	Lithuanian	8465	ta	Tamil
6890	dz	Bhutani	7686	lv	Latvian, Lettish	8469	te	Telugu
6976	el	Greek	7771	mg	Malagasy	8471	tg	Tajik
6978	en	English	7773	mi	Maori	8472	th	Thai
6979	eo	Esperanto	7775	mk	Macedonian	8473	ti	Tigrinya
6983	es	Spanish	7776	ml	Malayalam	8475	tk	Turkmen
6984	et	Estonian	7778	mn	Mongolian	8476	tl	Tagalog
6985	eu	Basque	7779	mo	Moldavian	8478	tn	Setswana
7065	fa	Persian	7782	mr	Marathi	8479	to	Tonga
7073	fi	Finnish	7783	ms	Malay	8482	tr	Turkish
7074	fj	Fiji	7784	mt	Maltese	8483	ts	Tsonga
7079	fo	Faeroese	7789	my	Burmese	8484	tt	Tatar
7082	fr	French	7865	na	Nauru	8487	tw	Twi
7089	fy	Frisian	7869	ne	Nepali	8575	uk	Ukrainian
7165	ga	Irish	7876	nl	Dutch	8582	ur	Urdu
7168	gd	Scots Gaelic	7879	no	Norwegian	8590	uz	Uzbek
7176	gl	Galician	7967	oc	Occitan	8673	vi	Vietnamese
7178	gn	Guarani	7977	om	(Afan) Oromo	8679	vo	Volapük
7185	gu	Gujarati	7982	or	Oriya	8779	wo	Wolof
7265	ha	Hausa	8065	pa	Punjabi	8872	xh	Xhosa
7273	hi	Hindi	8076	pl	Polish	8979	yo	Yoruba
7282	hr	Croatian	8083	ps	Pashto, Pushto	9072	zh	Chinese
7285	hu	Hungarian	8084	pt	Portuguese	9085	zu	Zulu
7289	hy	Armenian	8185	qu	Quechua			
7365	ia	Interlingua	8277	rm	Rhaeto-Romance			

# LISTENING TO OTHER SOURCES

## Listening to the TV connected to the AV EURO/TV (AUDIO) IN (RGB OUT) socket

1. Press the FUNCTION button to select "TV".
2. Follow the instructions supplied with the TV.

## Listening to the video equipment connected to the VIDEO (AUDIO) IN sockets

1. Press the FUNCTION button to select "VIDEO".
2. Follow the instructions supplied with the video equipment.

# LISTENING TO THE RADIO

To turn the unit on and listen to the last received station, press the TUNE/BAND button.

## Automatic/Manual tuning

1. Press the TUNE/BAND button to select FM or AM.
2. **Automatic tuning**  
Press the TUNE/PTY + or – button for at least 1 second to tune in a station. The unit will scan up or down the band and receive the next receivable station. Press the button again to continue.

### Manual tuning

Press the TUNE/PTY + or – button briefly until the desired frequency is displayed.

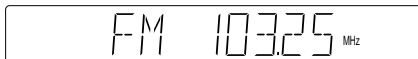

## To preset stations

Up to 24 FM and 12 AM stations can be preset.

### Automatic presetting (APT)

1. Press the TUNE/BAND button to select FM or AM.
2. Press the PROGRAM button for at least 3 seconds. "PROG." blinks. The automatic tuning mode is set and automatic presetting begins from the low end of the band.  
When 24 FM or 12 AM stations have been preset or the high end of the band is reached, automatic presetting stops. "PROG." disappears and the station memorized on channel 1 will be heard.
3. To preset stations on the other band, follow steps above.

Note:

If APT is activated, all previously programmed stations of the band will be cleared and new stations will be programmed.

### Manual presetting

1. Tune in the station to be preset as described in "Automatic/Manual tuning".
2. Press the PROGRAM button.

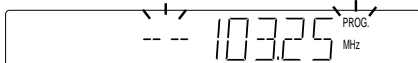

3. While "PROG." is blinking, press the PRESET + or – button to select the channel to be preset.
  - The number button(s) can also be used. Example: Press 9.

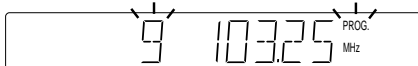

4. While "PROG." is blinking, press the ENTER button.
  - In this example, "103.25 MHz" FM station is preset on FM channel 9.

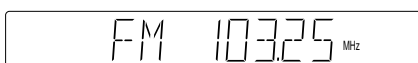

5. Repeat steps above to add more preset stations.
  - When presetting a new station, the previous preset station is cleared.

## Listening to preset stations

1. Press the TUNE/BAND button to select FM or AM.
2. Press the PRESET + or – button briefly to select the desired channel.
  - The number button(s) can also be used. Example: Press 9 then ENTER.

### Preset scan tuning

1. Press the TUNE/BAND button to select FM or AM.
2. Press the PRESET + (▶▶) button for at least 1 second. The channel number appears. Each of the preset stations is tuned in for 5 seconds.
3. When the desired station has been tuned in, press the PRESET + (▶▶) button again to keep the reception locked at that station.

## When beat interference is heard

A high-pitched noise called "beat" is sometimes heard during reception of radio broadcasts. If this occurs, While pressing the ■ button on the main unit, press the TEST button on the remote control to select "bc-A" or "bc-B". Select the setting that gives the best results.

### Changing the AM reception frequencies

It is not necessary to perform this procedure in the Europe.

1. Press the TUNE/BAND button to select "AM".
2. While pressing the ■ button on the main unit, press the PROGRAM button on the remote control.

522 - 1611 kHz (9 kHz steps) ↔ 520 - 1610 kHz (10 kHz steps)

## Listening to FM stations with RDS

RDS (Radio Data System) permits FM stations to send additional signals with the regular programme signals. For example, the stations send their station names and information about what type of broadcast programmes, such as sports or music, etc.

When tuned in FM broadcast which provides the RDS service, the "PS" RDS mode is set automatically and the station name appears on the display.

Note:

- Some FM broadcasts do not provide RDS service.
- RDS may not work correctly if the signal strength is weak.
- RDS is not available for AM broadcasts.

### Selecting the RDS mode

Press the RDS button while listening to an FM station. Each time the button is pressed, the display mode changes as follows.

PS → PTY → RT → Frequency

#### PS (Programme Service)

The station name is displayed. If no PS signal is received, "NO PS" appears, then station frequency is displayed.

#### PTY (Programme Type)

The broadcast programme type is displayed. If no PTY signal is received, "NO PTY" appears, then station name or station frequency is displayed.

#### RT (Radio Text)

Text messages the station sends will be displayed. If no RT signal is received, "NO RT" appears.

#### Frequency

Station frequency (non-RDS service)

After several seconds, the PS mode returns if RDS signal is received.

### To search a preset station by PTY codes

A particular programme type broadcast can be located by specifying the PTY codes.

1. Press the RDS button to select "PTY" while listening to an FM broadcast.
2. Press the TUNE/PTY + or - button within 2 seconds to select the desired PTY code. The PTY code changes as shown below;

NEWS → AFFAIRS → INFO → SPORT → EDUCATE → DRAMA → CULTURE → SCIENCE → VARIED → POP M → ROCK M → M.O.R. M → LIGHT M → CLASSICS → OTHER M → WEATHER → FINANCE → CHILDREN → SOCIAL → RELIGION → PHONE IN → TRAVEL → HOBBIES → JAZZ → COUNTRY → NATION M → OLDIES → FOLK M → DOCUMENT → TEST → ALARM  
(or in the reverse sequence)

3. Press the PTY CHK (▶▶) button within 4 seconds.  
The unit searches 24 preset stations and stops when it finds a broadcast of the PTY code you have selected, then tunes into that station.
  - To continue searching after the first stop, repeat steps 1 - 3 above.
  - If no broadcast is found, the original station is heard.

To cancel searching, press the RDS button.

## TIMER OPERATION

### Using the timer

Set the on and off times, function to be used and volume level. Operation will start with the selected function at the on time. The sound will be gradually increased from a no-sound level to the volume setting (fade-in). The power will be switched off at the off time.

The timer will function every day unless it is released.

#### Preparation

Note:

Make absolutely sure that the clock is set to the correct time before setting the timer.

- Select the function for timer operation and prepare the sources to be used.
  - If the function selected is tuner, tune in to the desired band and station.
- Adjust the volume level as desired.

#### Operation

1. Press the SHIFT + 7 TIMER buttons.



The previous timer on time setting appears.

2. Press the SHIFT + 8 ADJUST buttons within 10 seconds.



3. Set the hours of timer on time by pressing the ▶▶ or ◀◀ button, then press the SHIFT + 8 ADJUST buttons.

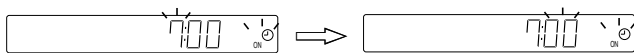

Set the minutes in the same way.

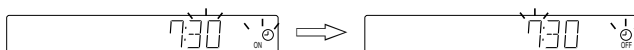

The timer off time setting appears.

4. Set the timer off time as described in step 3. The original display returns, then the timer operation standby mode is activated. "ON" remains lit.
5. Press the ⏻/ON button to switch off the power, you will see GOOD BYE and "OFF" this will go off after 2 seconds.

- "OFF" blinks during a timer-controlled operation.
- If you wish to switch off the power during a timer-controlled operation, press the ⏻/ON button and the timer will be set in the standby mode.

### To check the timer settings

Press the SHIFT + 7 TIMER buttons repeatedly. The timer settings are displayed in the following order:

On time → Off time → Function → Original display returns

To change the settings, press the SHIFT + 7 TIMER buttons to select the setting to be changed, then press the SHIFT + 8 ADJUST buttons so that the display blinks. Change the setting as explained above.

### To release the timer

After turning the power on, press the SHIFT + 7 TIMER buttons, then press the SHIFT + 9 SET/CLEAR.

### To set the timer again with the same settings

1. Press the SHIFT + 7 TIMER buttons, then the SHIFT + 9 SET/CLEAR.
2. Press the ⏻/ON button to switch off the power.

Note:

- If the SHIFT + 9 SET/CLEAR buttons are pressed while the timer is being set, the original display returns.
- The timer mode is released if a power failure occurs during timer controlled operation.
- The timer may not operate if a power failure occurs during timer operation standby mode.

### Using the sleep timer

The sleep timer automatically switches off the power after a preset time has elapsed. The volume will gradually be reduced (fade-out) during the 1-minute period before the unit turns off. There are 4 time periods available: 30, 60, 90 and 120 minutes.

Press the SHIFT + 6 SLEEP buttons repeatedly to select the desired sleep time. "SLEEP" and the selected time blink on the display. After several seconds, the original display returns and the brightness of the display reduces. "SLEEP" blinks.

### To check the remaining sleep time

Press the SHIFT + 6 SLEEP buttons once. After several seconds, the original display returns.

### To release the sleep timer while in operation

Press the SHIFT + 6 SLEEP buttons, then press the SHIFT + 9 SET/CLEAR buttons. The timer is also released if the power is switched off.

# MAINTENANCE

## Cleaning the unit

Clean the outside of the unit with a clean soft cloth moistened with lukewarm water. Do not use benzene, thinner or alcohol since they will mar the finish of the surfaces.

# TROUBLESHOOTING GUIDE

If you have followed the instructions and are having difficulty operation the unit, locate the SYMPTOM in the left column below. Check the corresponding POSSIBLE CAUSE and CORRECTIVE ACTION columns to locate and remedy the problem.

SYMPTOM	POSSIBLE CAUSE	CORRECTIVE ACTION
No picture.	The wrong function is selected.	Select the correct function.
	No disc is loaded or an unplayable disc is loaded.	Load a disc or load a playable disc. (Check the disc logo, type, colour system and regional code.)
	The TV is not set to receive signal from the unit.	Select the correct input function on the TV.
No sound.	The wrong function is selected.	Select the correct function.
	Volume control is set to minimum.	Turn up the volume.
The playback picture is poor.	An unplayable disc is loaded.	Load a playable disc. (Check the disc logo, type, colour system and regional code.)
"⊗" appears on the TV screen.	The selected function does not operate on the disc now.	The feature or action cannot be completed at this time because: <ul style="list-style-type: none"> <li>- The feature is not available at the moment.</li> <li>- The DVD software restricts it.</li> <li>- The DVD software does not support the feature (e.g., angles).</li> </ul>
The player does not start play.	No disc is loaded.	Load a disc.
	An unplayable disc is loaded.	Load a playable disc. (Check the disc logo, type, colour system and regional code.)
	The disc is loaded with the label side down.	Load the disc on the disc tray correctly.
	The disc is dirty.	Clean the disc or replace it.
	"Parental" is set.	Cancel the parental lock function or change the rating level. Reset it after play.
The operation or display is not normal.	The memory must be reset.	<ol style="list-style-type: none"> <li>1. Disconnect the mains lead.</li> <li>2. Press the RESET button (bottom of the unit) for at least 30 seconds.</li> </ol>
The remote control does not work properly.	The batteries in the remote control are weak, or installed incorrectly.	Check the battery polarity (+ or -). Replace the batteries.
	The remote control is not aimed at the remote sensor window.	Aim the remote control at the remote sensor window.



# SPECIFICATIONS

## Amplifier

### Main amplifier

#### Stereo mode

26 W x 2 (at 8 ohms, 10% distortion)

#### Dolby Digital mode

26 W x 2 (at 8 ohms, 10% distortion, with Centre/Surround/  
Subwoofer amplifier off)

### Centre amplifier

26 W (at 8 ohms, 10% distortion, with Main/Surround/Subwoofer  
amplifier off)

### Surround amplifier

26 W x 2 (at 8 ohms, 10% distortion, with Main/Centre/Subwoofer  
amplifier off)

### Subwoofer amplifier

50 W (at 4 ohms, 10% distortion, with Main/Centre/Surround  
amplifier off)

### Input:

VIDEO (AUDIO) IN: 500 mV/50 k $\Omega$

### Input/Output:

AV EURO/TV (AUDIO) IN (RGB OUT): For Euro-AV/Scart lead

### Outputs:

#### SPEAKERS:

FRONT (L/R): 8  $\Omega$

CENTER: 8  $\Omega$

SURROUND (L/R): 8  $\Omega$

SUBWOOFER: 4  $\Omega$

#### MONITOR OUT:

##### S-VIDEO:

Y: 1.0 Vp-p (75  $\Omega$ )

C: 0.3 Vp-p (75  $\Omega$ ) PAL, 0.286 Vp-p (75  $\Omega$ ) NTSC

VIDEO: 1.0 Vp-p (75  $\Omega$ )

## DVD Player

### Type:

DVD video player

### Playback standard:

PAL or NTSC

### Laser:

Semiconductor laser, wavelength: 650/790 nm

Laser output (Continuous wave max.):

1 mW (DVD)

0.5 mW (CD)

### Signal to noise ratio:

More than 105 dB

### Harmonic distortion

0.003 %

### Wow and flutter:

Below measurable level

## Tuner

### Reception frequency:

FM: 87.5 - 108 MHz

AM: 522 - 1611 kHz

## General

### Power requirements:

AC 230 V, 50 Hz

### Power consumption:

120 W

1.5 W (standby mode)

### Dimensions:

435(W) x 75(H) x 375(D) mm

### Weight:

6.4 kg

## Speaker system

### Front left, Front right, Centre, Surround left and Surround right speakers (SX-TS750S, magnetic shield)

#### Unit used:

8 cm cone type, full range

#### Maximum power handling capacity:

40 W (peak)

#### Nominal impedance:

8  $\Omega$

#### Dimensions:

125(W) x 105(H) x 112(D) mm

#### Weight:

0.72 kg/speaker

### Subwoofer (SX-TS750W)

#### Unit used:

13 cm cone type

#### Maximum power handling capacity:

80 W (peak)

#### Nominal impedance:

4  $\Omega$

#### Dimensions:

160(W) x 415(H) x 310(D) mm

#### Weight:

4.9 kg

## IMPORTANT INFORMATION

Because its products are subject to continuous improvement, SANYO reserves the right to modify product designs and specifications without notice and without incurring any obligation.





## **GUARANTEE TO CUSTOMER**

Sanyo Europe Ltd. (the Company) guarantees to the initial retail purchaser that if this equipment is or becomes defective and that, in the opinion of the Company, the defect is due to faulty material or workmanship the Company will, for a period of 12 calendar months from the date of sale to the original purchaser repair or replace, at its sole option, free of charge, any such defective component part of the equipment, always provided that: -

1. The equipment has at all times been used in accordance with the operating instructions issued by the Company, and has not been connected to an electrical mains supply for which it has not been adjusted.
2. Accidental damage, or damage caused by negligence or misuse by the user, including leakage from exhausted batteries, is specifically excluded.
3. Unauthorised repairs, or any modification to the equipment which has not been expressly approved by the Company, shall render this guarantee null and void.
4. Failure due to fair wear and tear of any item, such as batteries, record playing styli, and tape recording, playback and erase heads is specifically excluded.

This guarantee is not transferable and is only applicable within the United Kingdom (and the Republic of Ireland). Nothing in this express guarantee affects the statutory rights available to the purchaser of this equipment.

Note: This guarantee supersedes any other form of guarantee that may inadvertently have been enclosed with or attached to the product. (August 1978).

*Dear Customer*

Thank you for buying Sanyo. This equipment should give you many years of pleasure and faithful service but in the event that a fault occurs, the following notes for your guidance may be helpful:-

1. PLEASE RETAIN YOUR PURCHASE RECEIPT WHICH WILL BE REQUIRED FOR SERVICE DURING GUARANTEE.
2. If your Sanyo equipment proves faulty during the period of guarantee, take it or send it back to the dealer who originally supplied it together with this guarantee and the proof of purchase. We have made arrangements with our approved dealers under which they will carry out in-guarantee service repairs on our behalf. In this way, we hope to reduce to a minimum the amount of time you will be without your equipment.
3. If for some reason it is impossible to return the equipment to the original supplier, please contact our Consumer Relations Department at the address below for further advice.
4. Should the equipment require servicing after the expiry of the guarantee period, take or send it to the original supplier or any other Sanyo dealer. He will be pleased to give you a quotation for the repair. If you are in any doubt about what to do, write to us at the address below or telephone:

**Consumer Relations Department,  
Sanyo Europe Ltd.,  
Sanyo House  
Otterspool Way, Watford,  
Hertfordshire WD2 8JX  
Tel: Watford 246363**

R5

The Sanyo logo consists of the word "SANYO" in a bold, sans-serif font. The letter "Y" is stylized with multiple vertical lines of varying lengths passing through it, creating a sense of motion or a multi-dimensional effect.

**SANYO Electric Co., Ltd.**